

## US ROUTE 4 – BRIDGE 61 OVER OTTAUQUECHEE RIVER



# Construction Schedule Public Information Meeting

July 27, 2023

# Tonight's Agenda

---

1. Introductions
2. Project Overview
  - Plan Requirements
  - Contract Specifications
3. Project Schedule
  - Traffic Control
  - Major Activities
4. Discussion



# Introductions

---

## **Vermont Agency of Transportation**

- J. B. McCarthy, PE, Project Manager
- Tom Chase, Resident Engineer

## **Gill Engineering**

- Amy Spera, PE, Project Manager

## **Harrison & Burrowes Bridge Constructors, Inc.**

- Greg Domermuth

## **FHI Studio – Public Outreach**

- Marcy Miller, AICP
- Nick Campbell

---

# Project Overview

# Existing Bridge Cross Section

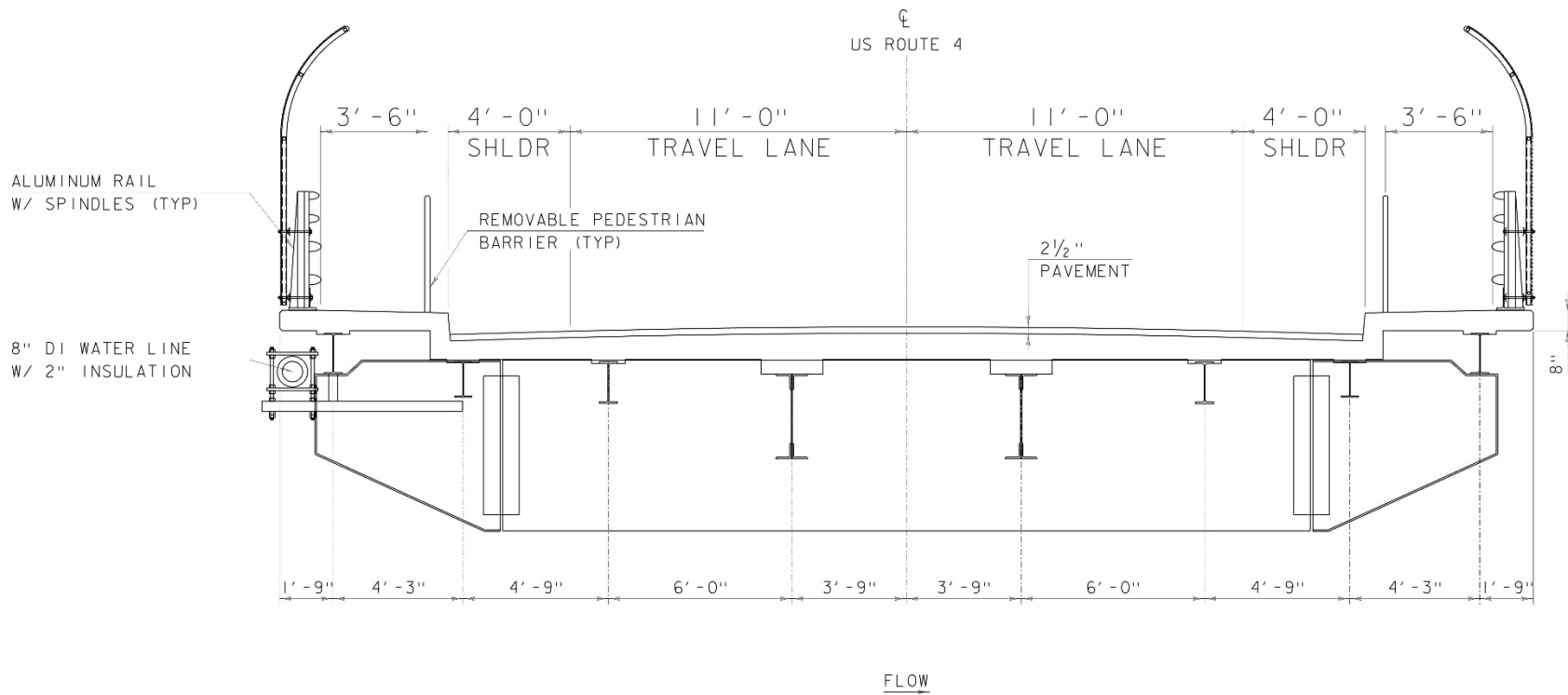

# Construction Phase 1 - 2024

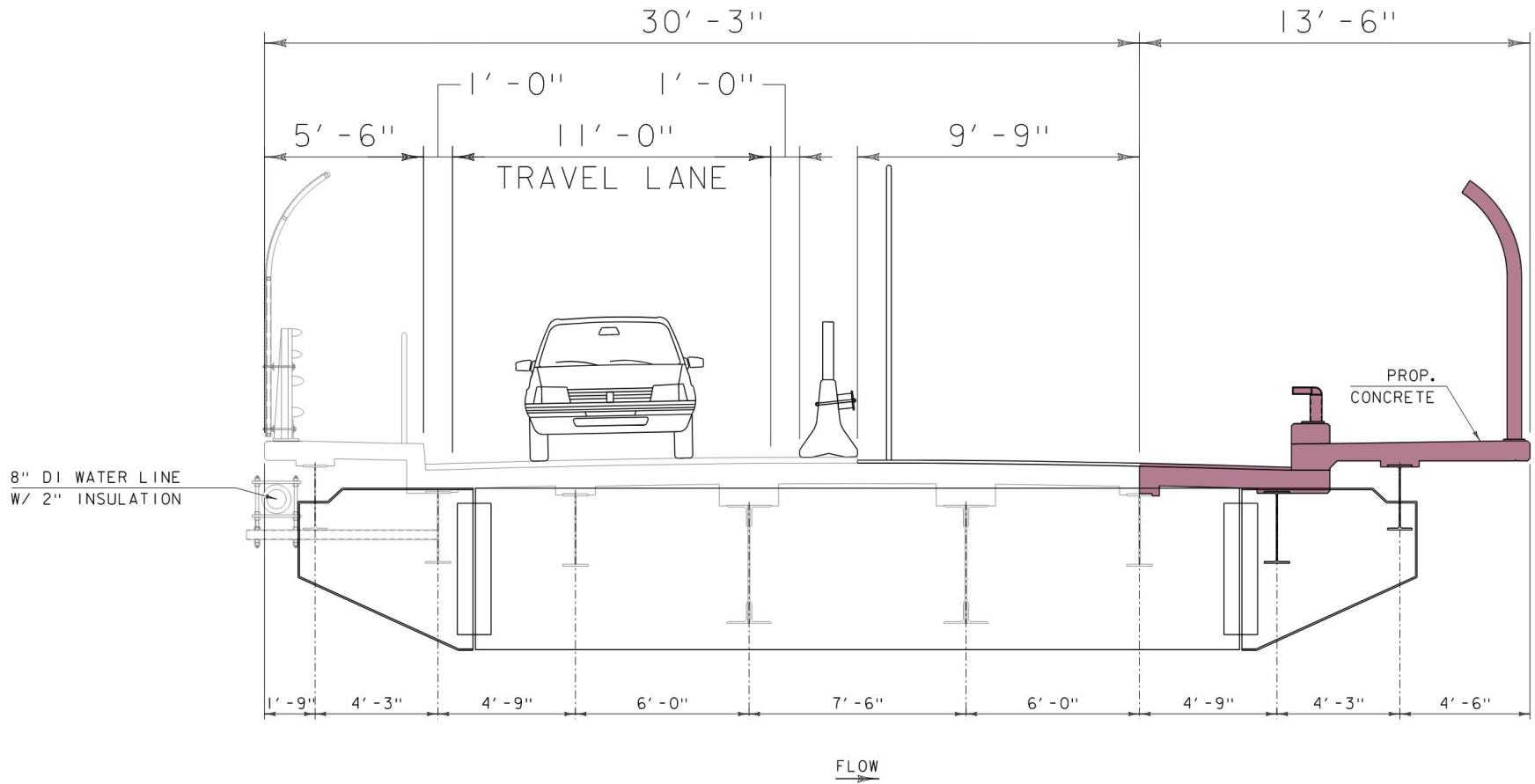

# Construction Phase 2 - 2025

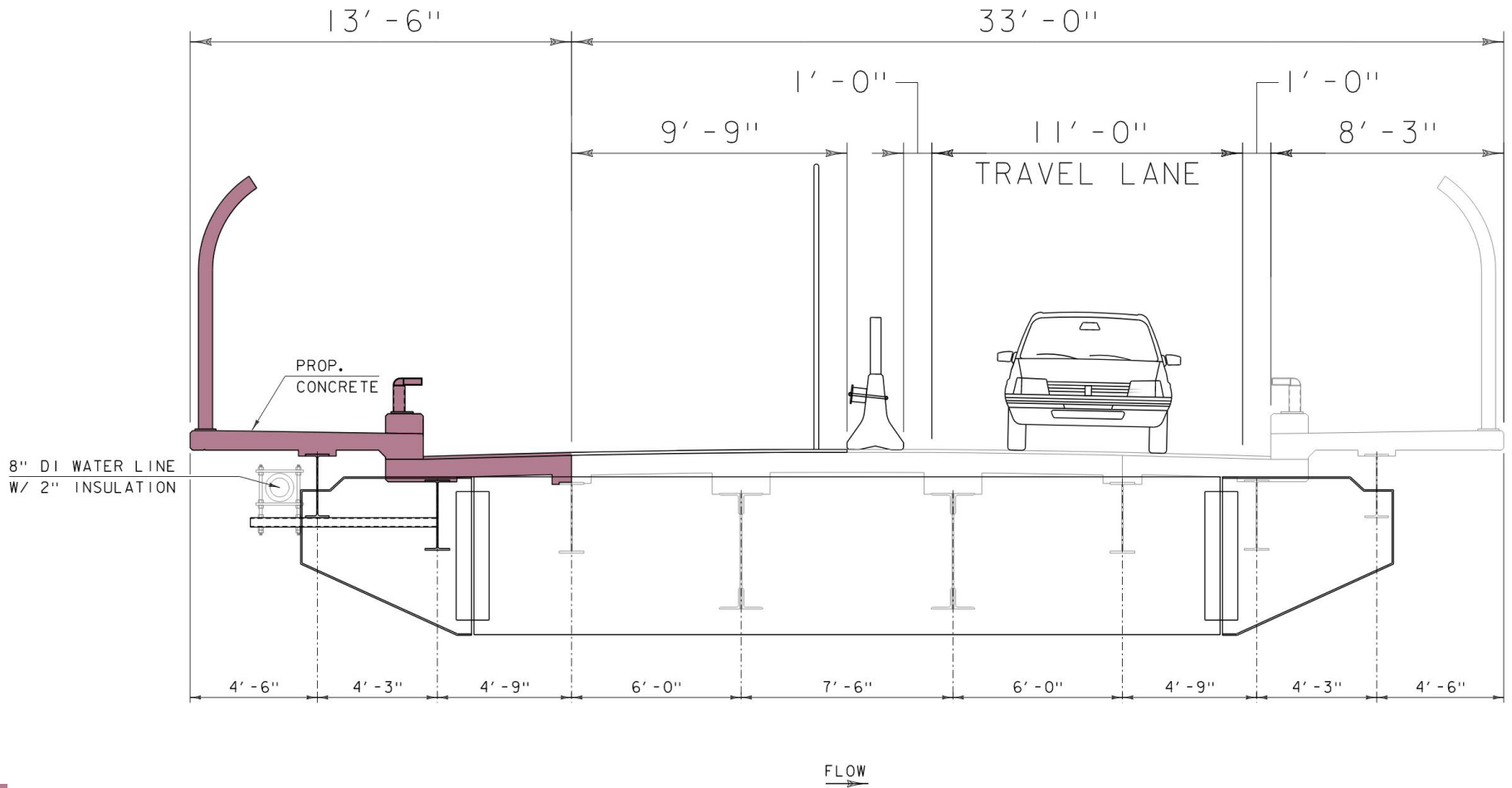

# Construction – Final

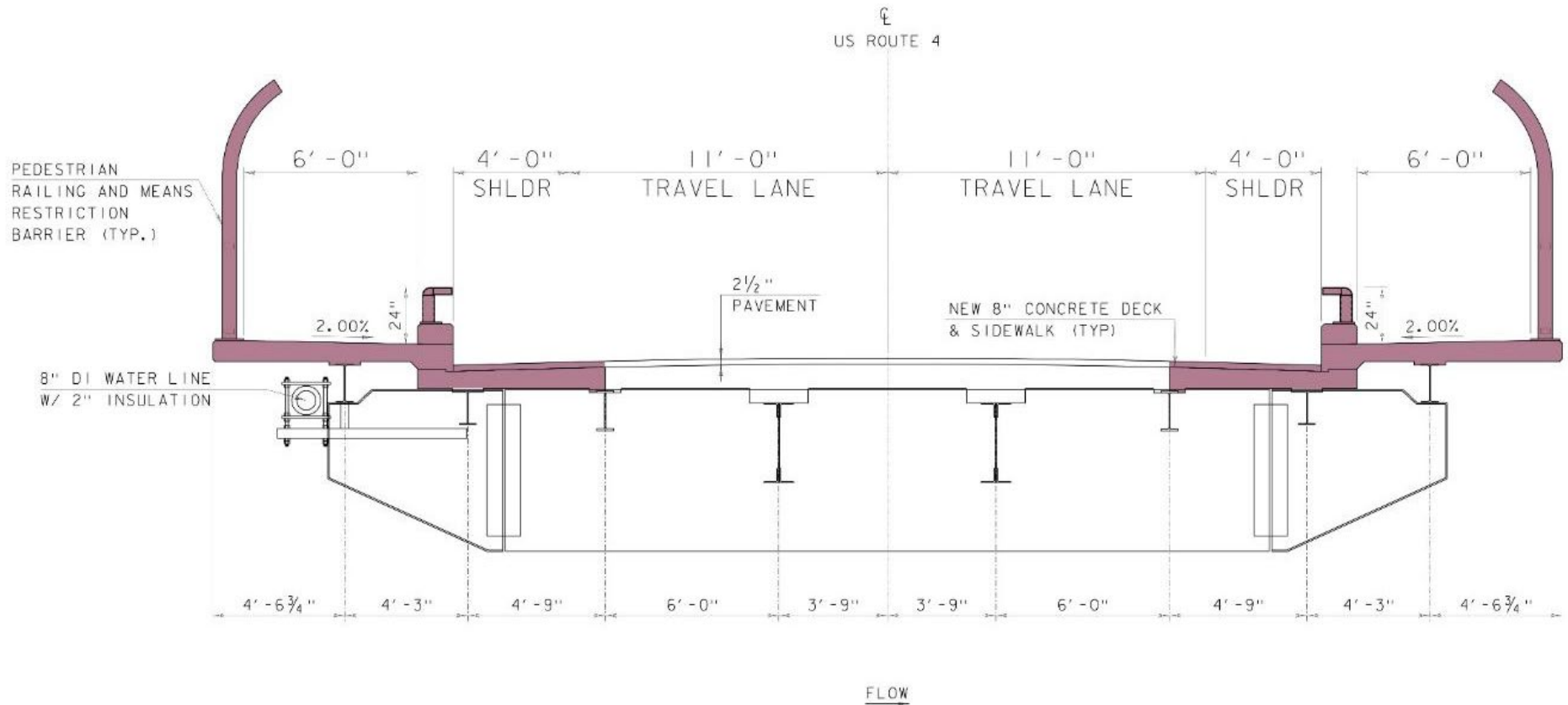



# Proposed Sidewalk Connectivity

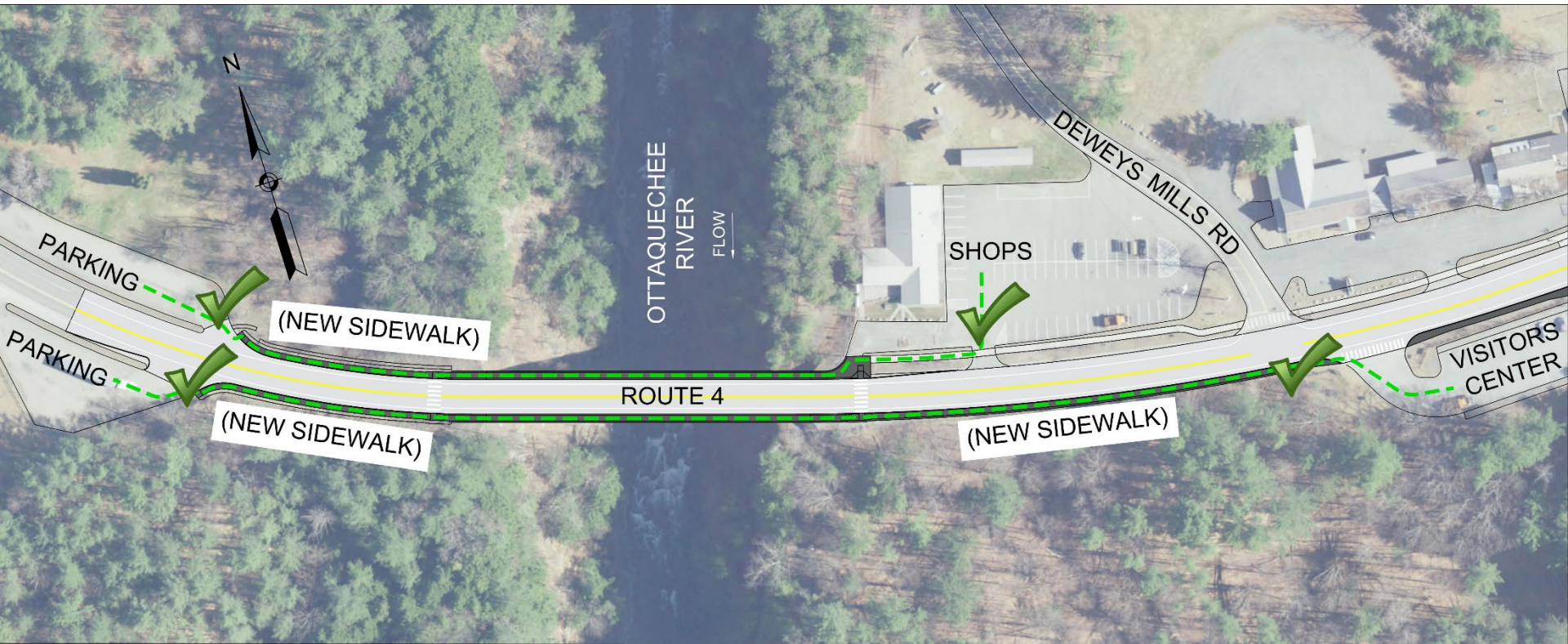

---

# Project Schedule

# Construction Phasing

---

- Construct sequencing
  - 2023 - Cleaning and painting structural steel
  - 2024 - Phase 1 sidewalk reconstruction
  - 2025 - Phase 2 sidewalk reconstruction
  - 2026 – Project cleanup (project completion date: June 26, 2026)
- Traffic control in place:
  - 2023            August thru November
  - 2024            April thru November
  - 2025            April thru November
  - 2026            April thru June
- Roadway width reduced to one lane of alternating traffic
- One sidewalk will remain open throughout construction



# Phase 2 – Traffic Control 2025

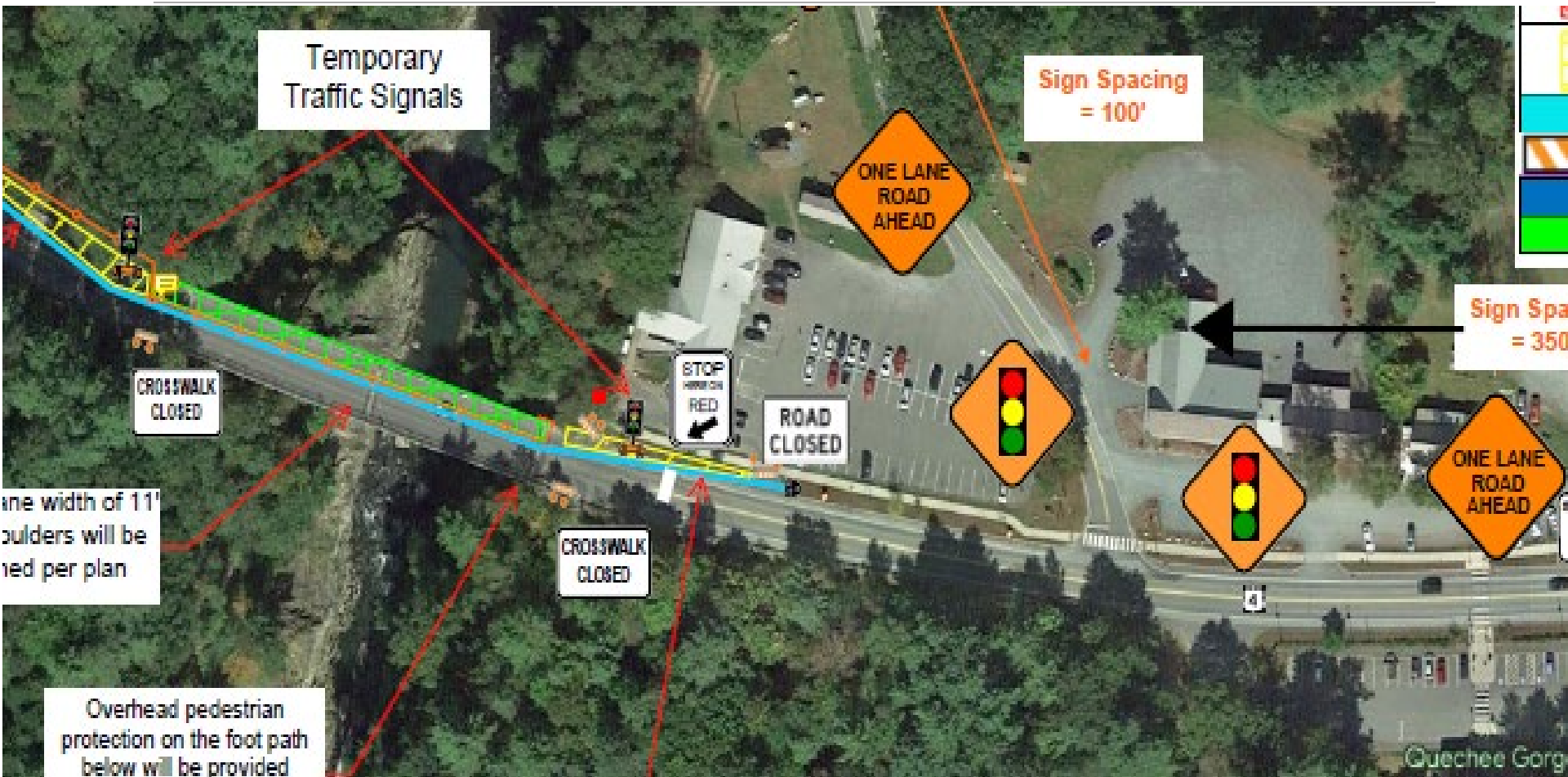

# 2023 Construction Timeline

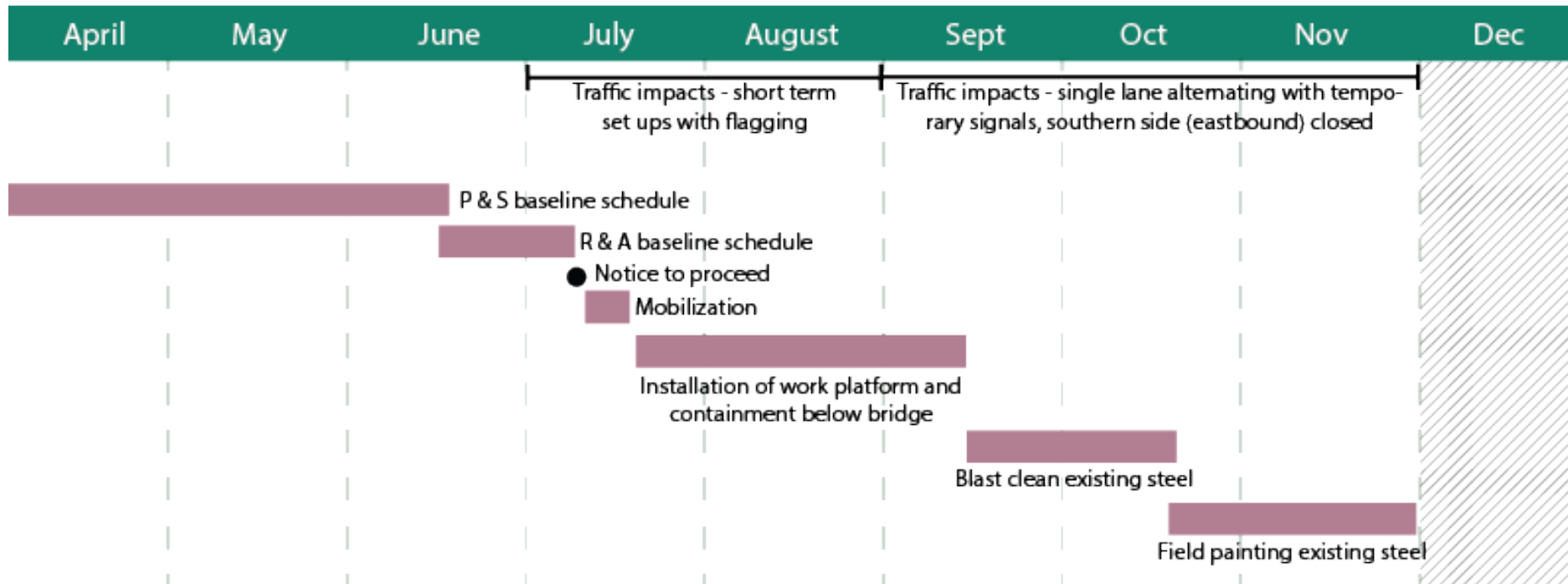

# 2024 Construction Timeline

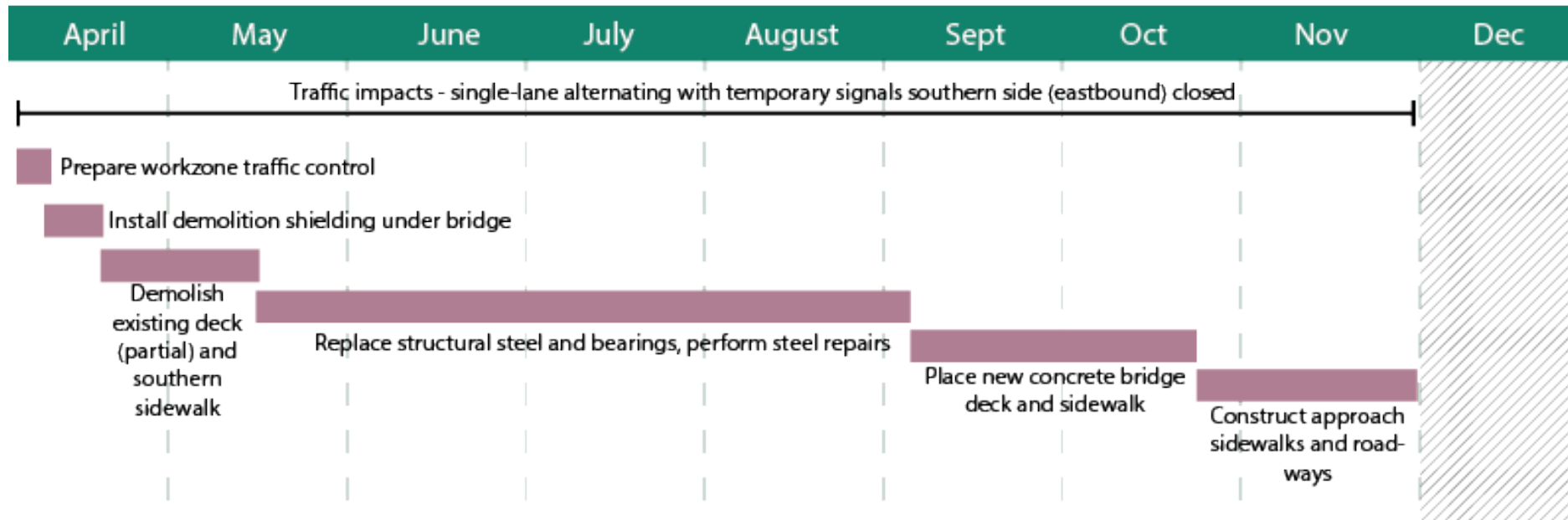

# 2025 Construction Timeline

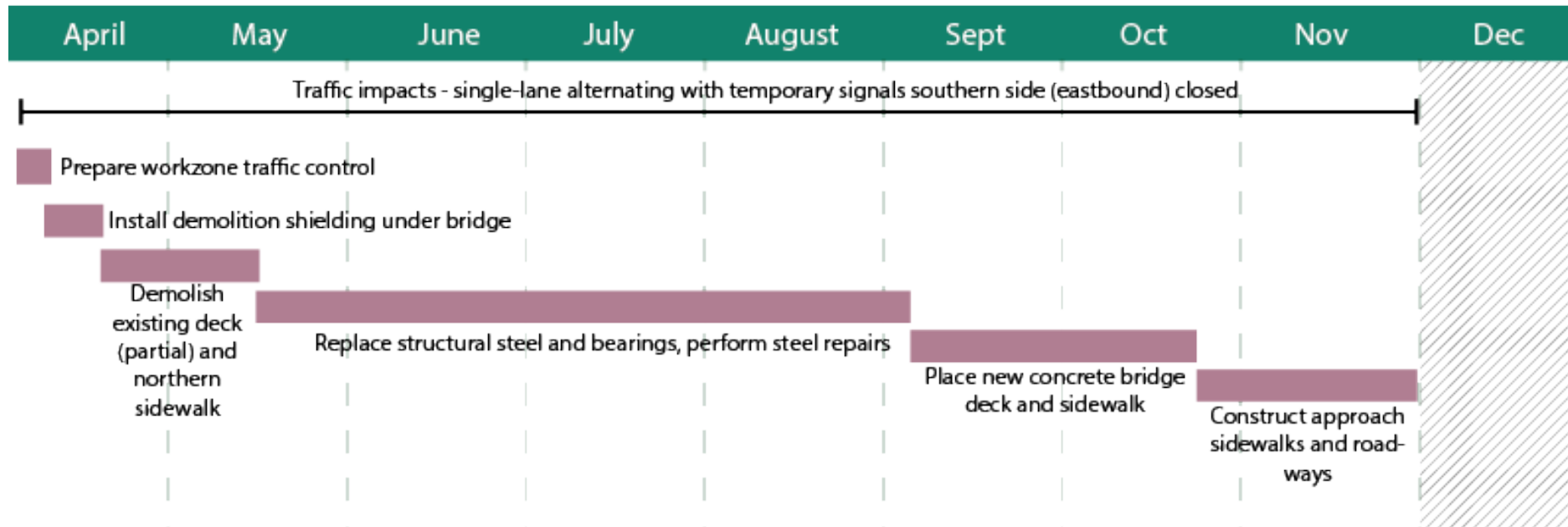



# 2026 Construction Timeline

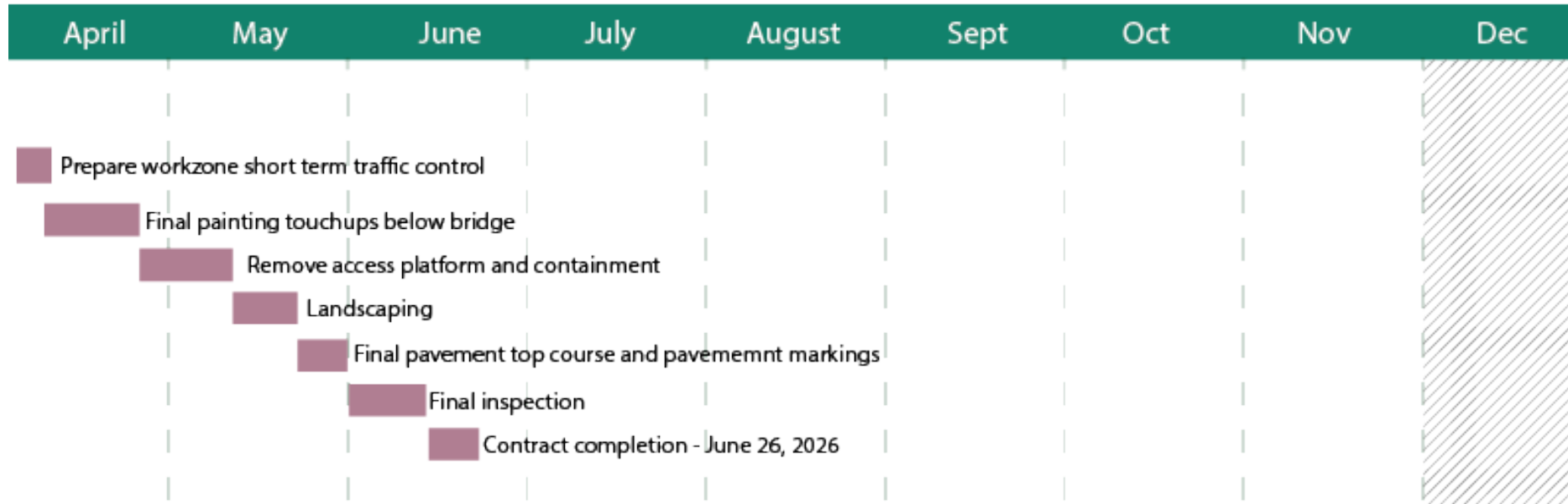

---

# Discussion



Thank you!

<http://vtrans.vermont.gov/projects/quechee>